



UNIVERSITY OF
GOTHENBURG

Verification of concurrent programs

Lecture 13 of TDA384/DIT391

Principles of Concurrent Programming

Nir Piterman

Chalmers University of Technology | University of Gothenburg
SP1 2020/2021

Based on course slides by Carlo A. Furia and Sandro Stucki

Today's menu

Finite-state models of concurrency: recap

Specification

Verification

Testing

Model checking

Finite-state models of concurrency: recap

State/transition diagrams

We capture the essential elements of concurrent programs using **state/transition diagrams** (also called: (finite) state automata, (finite) state machines, or transition systems).

- **states** in a diagram capture possible program states
- **transitions** connect states according to execution order

Structural properties of a diagram capture semantic properties of the corresponding program.

States

A **state** captures the shared and local states of a concurrent program:

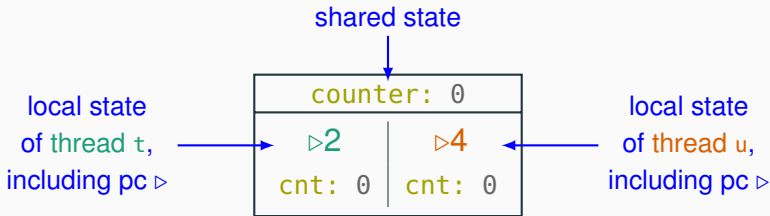

```
int counter = 0;
```

thread **t**

```
int cnt;  
1 cnt = counter;  
2 counter = cnt + 1;  
3 // terminates
```

thread **u**

```
int cnt;  
cnt = counter; 4  
counter = cnt + 1; 5  
// terminates 6
```

States

A **state** captures the shared and local states of a concurrent program:

counter: 0	
▷2	▷4
cnt: 0	cnt: 0

When unambiguous, we simplify a state with only the **essential information**:

0	
▷2	▷4
0	0

Initial states

The **initial state** of a computation is marked with an incoming arrow:

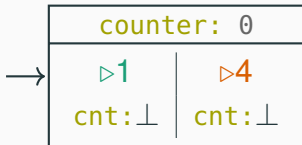

```
int counter = 0;
```

thread t

```
int cnt;
1 cnt = counter;
2 counter = cnt + 1;
3 // terminates
```

thread u

```
int cnt;
cnt = counter;           4
counter = cnt + 1;      5
// terminates           6
```

Final states

The **final states** of a computation – where the program terminates – are marked with double-line edges:

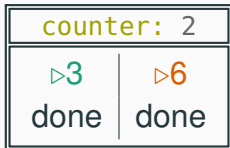

```
int counter = 0;
```

	thread t		thread u
	<pre>int cnt;</pre>		<pre>int cnt;</pre>
1	<pre>cnt = counter;</pre>		<pre>cnt = counter;</pre>
2	<pre>counter = cnt + 1;</pre>		<pre>counter = cnt + 1;</pre>
3	<pre>// terminates</pre>		<pre>// terminates</pre>
			4
			5
			6

Transitions

A **transition** corresponds to the execution of one atomic instruction, and it is an arrow connecting two states (or a state to itself):

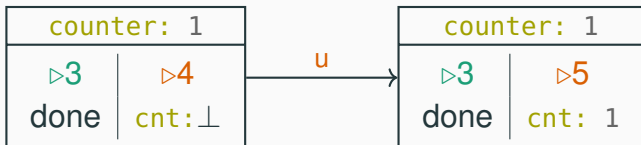

```
int counter = 0;
```

thread t

```
int cnt;
1 cnt = counter;
2 counter = cnt + 1;
3 // terminates
```

thread u

```
int cnt;
4 cnt = counter;
5 counter = cnt + 1;
6 // terminates
```

A complete state/transition diagram

The **complete** state/transition diagram for the concurrent counter example explicitly shows **all possible interleavings**:

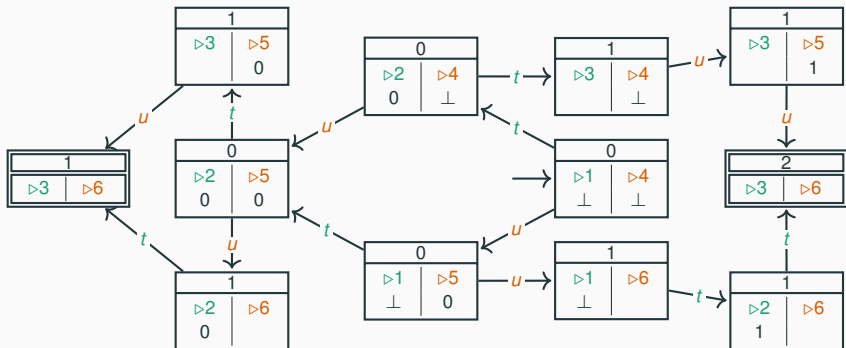

State/transition diagram with locks?

The state/transition diagram of the concurrent counter example using locks should contain **no (states representing) race conditions**:

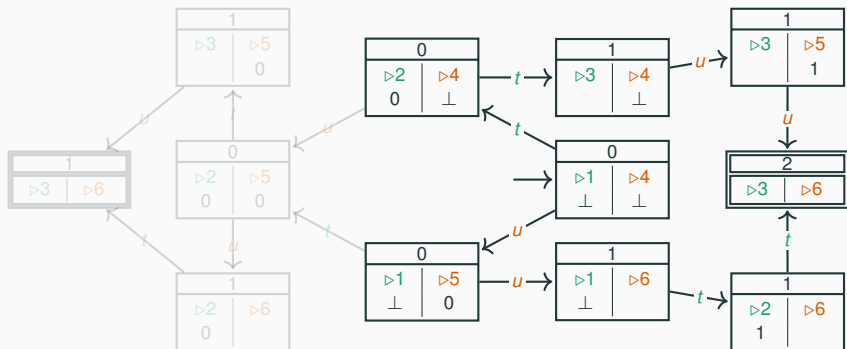

Locking

Locking and unlocking are considered atomic operations.



```
int counter = 0;    Lock lock = new ReentrantLock();
```

thread `t`

```
int cnt;  
1 lock.lock();  
2 cnt = counter;  
3 counter = cnt + 1;  
4 lock.unlock();  
5 // terminates
```

thread `u`

```
int cnt;  
lock.lock();           6  
cnt = counter;         7  
counter = cnt + 1;     8  
lock.unlock();         9  
// terminates         10
```

This transition is only allowed if the lock is **not held by another thread**.

Semaphores

Acquiring and releasing a semaphore are atomic operations.

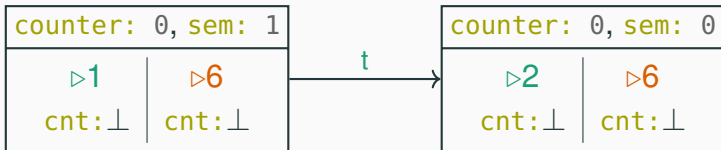

```
int counter = 0;      Lock sem = new Semaphore(1);
```

thread `t`

```
int cnt;  
1  sem.down();  
2  cnt = counter;  
3  counter = cnt + 1;  
4  sem.up();  
5  // terminates
```

thread `u`

```
int cnt;  
sem.down();           6  
cnt = counter;       7  
counter = cnt + 1;   8  
sem.up();            9  
// terminates       10
```

This transition is only allowed if the semaphore's value is **positive**.

Counter with locks: state/transition diagram

The state/transition diagram of the concurrent counter example using locks contains **no (states representing) race conditions**:

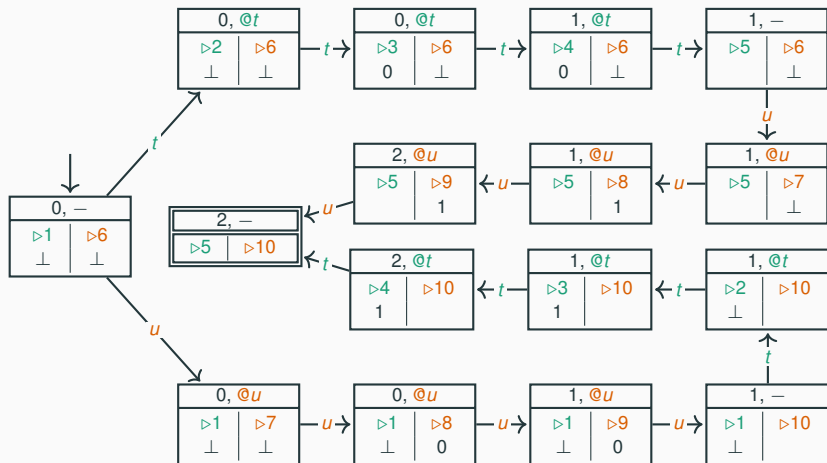

Simplifying state/transition diagrams

Tracking every statement can lead to large state diagrams. We can simplify a diagram by **skipping** lines irrelevant to concurrent behavior.

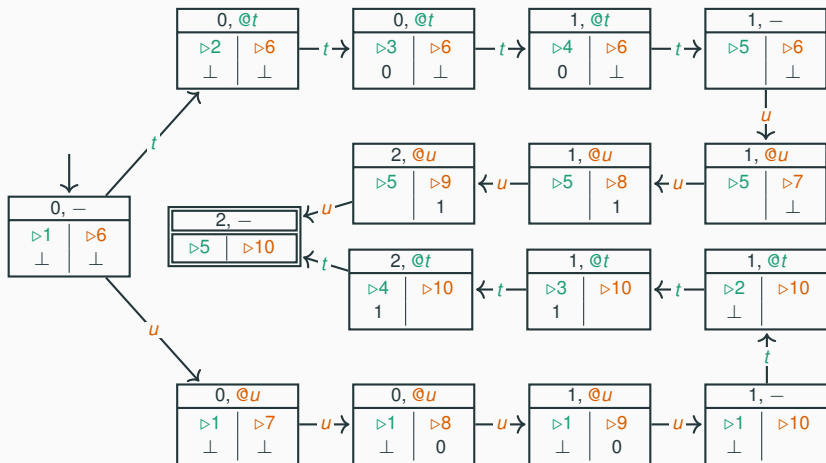

Simplifying state/transition diagrams

Tracking every statement can lead to large state diagrams. We can simplify a diagram by **skipping** lines irrelevant to concurrent behavior.

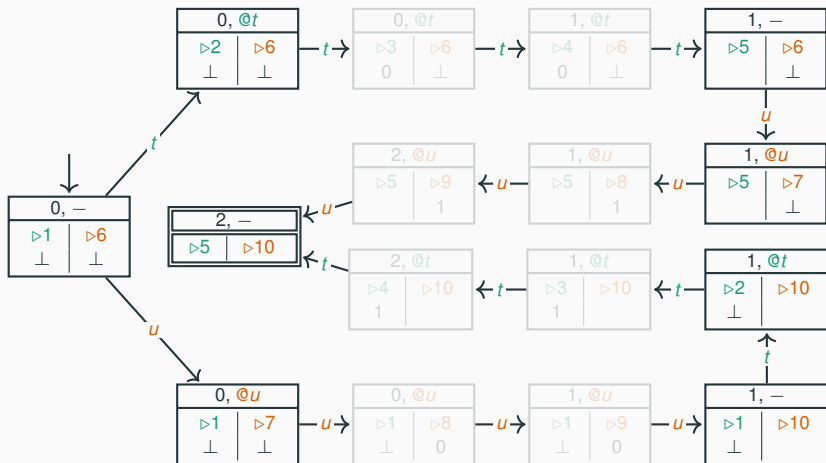

Simplifying state/transition diagrams

Tracking every statement can lead to large state diagrams. We can simplify a diagram by **skipping** lines irrelevant to concurrent behavior.

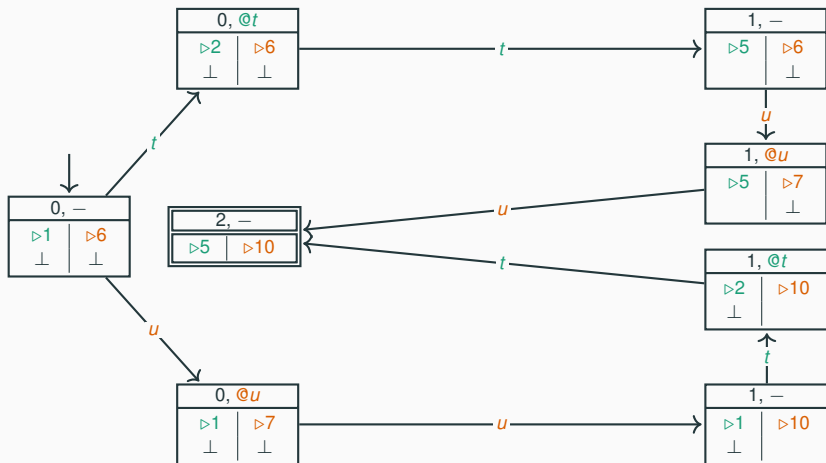

Simplifying state/transition diagrams

Tracking every statement can lead to large state diagrams. We can simplify a diagram by **skipping** lines **irrelevant to concurrent behavior**.

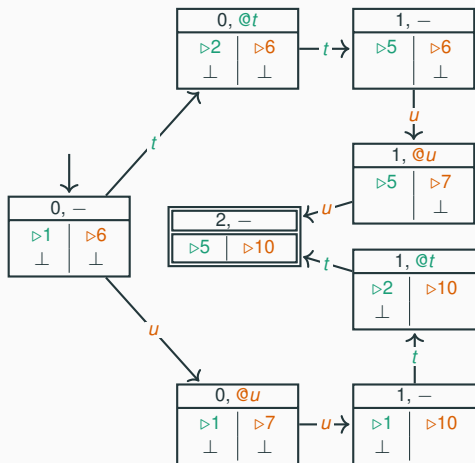

Simplifying state/transition diagrams

Tracking every statement can lead to large state diagrams. We can simplify a diagram by **skipping** lines **irrelevant to concurrent behavior**.

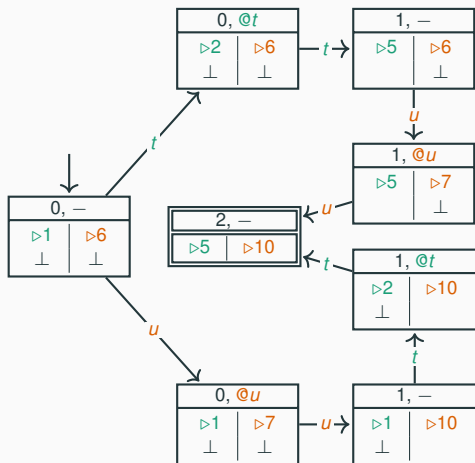

But we have to be **very careful** not to skip relevant lines!

Reasoning about program properties

The **structural properties** of a diagram capture semantic properties of the corresponding program:

mutual exclusion: there are no states where two threads are in their critical section;

deadlock freedom: for every (non-final) state, there is an outgoing transition;

starvation freedom: there is no (looping) path such that a thread never enters its critical section while trying to do so;

no race conditions: all the final states have the same result.

Building and analyzing state/transition diagrams by hand quickly becomes tedious. That's where **formal verification** techniques such as model checking can help.

Transition tables

Transition tables are equivalent representations of the information of state/transition diagrams.

CURRENT	NEXT WITH t	NEXT WITH u
$\langle 0, -, \triangleright 1, \perp, \triangleright 6, \perp \rangle$	$\langle 0, @t, \triangleright 2, \perp, \triangleright 6, \perp \rangle$	$\langle 0, @u, \triangleright 1, \perp, \triangleright 7, \perp \rangle$
$\langle 0, @t, \triangleright 2, \perp, \triangleright 6, \perp \rangle$	$\langle 1, -, \triangleright 5, -, \triangleright 6, \perp \rangle$	—
$\langle 0, @u, \triangleright 1, \perp, \triangleright 7, \perp \rangle$	—	$\langle 1, -, \triangleright 1, \perp, \triangleright 10, - \rangle$
$\langle 1, -, \triangleright 5, -, \triangleright 6, \perp \rangle$	—	$\langle 1, @u, \triangleright 5, -, \triangleright 7, \perp \rangle$
$\langle 1, -, \triangleright 1, \perp, \triangleright 10, - \rangle$	$\langle 1, @t, \triangleright 2, \perp, \triangleright 10, - \rangle$	—
$\langle 1, @u, \triangleright 5, -, \triangleright 7, \perp \rangle$	—	$\langle 2, -, \triangleright 5, -, \triangleright 10, - \rangle$
$\langle 1, @t, \triangleright 2, \perp, \triangleright 10, - \rangle$	$\langle 2, -, \triangleright 5, -, \triangleright 10, - \rangle$	—
$\langle 2, -, \triangleright 5, -, \triangleright 10, - \rangle$	—	—

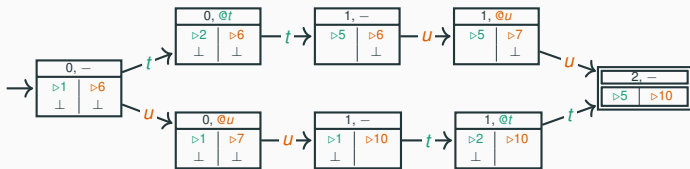

Specification

Writing correct programs

Programming means writing instructions that achieve a certain **functionality**. How do we know if a program is **correct**? And what does it even mean that a program is correct?

To this end, we distinguish between **implementation** and **specification**:

- The **implementation** is the code that is written, compiled, and executed.
- The **specification** is a description of what the program should do, usually at a more abstract level than the implementation.

Implementation:

```
void withdraw(int amount) {  
    balance -= amount;  
}
```

Specification:

method `withdraw` takes a positive integer amount not exceeding balance, and decreases balance by amount.

Functional specifications

In **sequential** programming, we are mainly interested in **functional** – or **input/output** – specifications of individual **methods**. Such specifications consist of two parts:

1. **precondition**: a constraint that defines the method's **valid inputs**,
2. **postcondition**: a functional description of the expected **output** after executing the method.

In object-oriented programs, the **input** and **output** of a method also include the object state before and after executing the method.

Implementation:

```
void withdraw(int amount) {  
    balance -= amount;  
}
```

Specification:

1. **precondition**:
 $0 < \text{amount} \ \&\& \ \text{amount} \leq \text{balance}$
2. **postcondition**:
“after” $\text{balance} ==$
“before” $\text{balance} - \text{amount}$

Pre/postconditions in Java

Java does not have support for writing pre/postcondition specifications in the source file.

JML (Java Modeling Language) is a system for annotating Java programs in special comments.

```
class BankAccount {  
    int balance;  
  
    //@ requires 0 < amount && amount <= balance;  
    //@ ensures balance == \old(balance) - amount;  
    void withdraw(int amount) {  
        balance -= amount;  
    }  
}
```

Invariants

In addition to pre- and postconditions of individual methods, functional specifications include class **invariants**, which specify properties of the state of objects of that class that should always hold between method calls.

```
class BankAccount {
    int balance;
    invariant { balance >= 0 } // balance never negative
        // (holds if withdraw is called with amount <= balance)
    void withdraw(int amount) {
        balance -= amount;
    }

    void deposit(int amount) {
        balance += amount;
    }
}
```

Specifications of concurrent programs

The specification of concurrent programs should cover two parts:

- a **functional** specification defines the correct **input/output** behavior;
- a **temporal** specification defines the **absence** of **undesired** behavior, such as no race conditions, deadlock, and starvation.

Functional specification techniques such as pre- and postconditions, and class invariants are also applicable to concurrent programs.

Class invariants are particularly useful for **shared-memory** concurrency, where invariants characterize the **valid states** of shared objects.

Temporal specifications require **new notations** and techniques.

Temporal logic

Temporal logic was invented by philosophers and later brought to computer science by Pnueli in the 1970s.

Temporal logic is a notation to **specify** behavior over time. More precisely, it formally defines properties of **traces** of states, like those that originate from the execution of a (concurrent) program.

Out of the many variants of temporal logic that have been developed, we present the widely used **LTL** (Linear Temporal Logic).

LTL operators

LTL includes all the usual **Boolean operators** of propositional logic:

FORMULA	MEANING
p	p is true
$\neg p$	p is not true (i.e., false)
$p \wedge q$	p and q are true
$p \vee q$	p or q is true (or both)
$p \Rightarrow q$	p true implies that q true (if p then q too)

LTL operators

LTL includes all the usual **Boolean operators** of propositional logic:

FORMULA	MEANING
p	p is true
$\neg p$	p is not true (i.e., false)
$p \wedge q$	p and q are true
$p \vee q$	p or q is true (or both)
$p \Rightarrow q$	p true implies that q true (if p then q too)

In addition, it has a few **temporal operators**:

FORMULA	MEANING
$\diamond p$	p is eventually true (from now on)
$\square p$	p is always true (from now on)
$p \cup q$	p is true (from now on) until q is true
Xp	p is true in the next step

LTL specifications

When we use LTL to specify properties of concurrent programs, **propositions** (like p and q) represent properties of a program's **global state** – including shared memory, and threads' local memory and program counters. For example:

PROPOSITION	STATE PROPERTY
c_t	thread t is in its critical section
c_u	thread u is in its critical section
e_t	thread t is trying to enter its critical section
n_t	thread t has terminated

With this convention, we can rigorously specify temporal properties.

LTL specifications: example

In our running example of concurrent increment of counter:

- each thread's **critical section** is the whole code it executes
- the **global state** includes: the value of counter, the values of the local cnt, and the program counter of each thread

```
int counter = 0;
```

thread t

```
int cnt;  
1 cnt = counter;  
2 counter = cnt + 1;  
3 // terminates
```

thread u

```
int cnt;  
cnt = counter; 4  
counter = cnt + 1; 5  
// terminates 6
```

LTL specifications: example

In our running example of concurrent increment of counter:

- each thread's **critical section** is the whole code it executes
- the **global state** includes: the value of counter, the values of the local cnt, and the program counter of each thread

```
int counter = 0;
```

thread t

```
int cnt;
1 cnt = counter;
2 counter = cnt + 1;
3 // terminates
```

thread u

```
int cnt;
cnt = counter;           4
counter = cnt + 1;      5
// terminates           6
```

PROPOSITION	MEANING
$t \triangleright k$	thread t is at line k
$u \triangleright k$	thread u is at line k

FORMULA	DEFINITION
e_t	$t \triangleright 1$
c_t	$t \triangleright 2$
n_t	$t \triangleright 3$

LTL specifications: example with locks

In our running example of concurrent increment of counter:

```
int counter = 0;    Lock lock = new ReentrantLock();
```

	thread t		thread u
	<pre>int cnt;</pre>		<pre>int cnt;</pre>
1	<pre>lock.lock();</pre>		<pre>lock.lock();</pre>
2	<pre>cnt = counter;</pre>		<pre>cnt = counter;</pre>
3	<pre>counter = cnt + 1;</pre>		<pre>counter = cnt + 1;</pre>
4	<pre>lock.unlock();</pre>		<pre>lock.unlock();</pre>
5	<pre>// terminates</pre>		<pre>// terminates</pre>

PROPOSITION	MEANING	FORMULA	DEFINITION
$t \triangleright k$	thread t is at line k	e_t	$t \triangleright 1$
$u \triangleright k$	thread u is at line k	c_t	$t \triangleright 2 \vee t \triangleright 3 \vee t \triangleright 4$
		n_t	$t \triangleright 5$

Mutual exclusion in LTL

Mutual exclusion means that no two threads are in the critical section at the same time. For a program with two threads t and u :

$$\Box \neg (c_t \wedge c_u)$$

“**Always** (in every state), it is **not** the case that both t **and** u are in their critical section.”

Deadlock freedom in LTL

A deadlock occurs when no thread makes progress; thus **deadlock freedom** is when some thread makes progress. For a program with two threads t and u :

PROPOSITION	STATE PROPERTY
e_t	thread t is trying to enter its critical section
e_u	thread u is trying to enter its critical section

$$\square \left((e_t \wedge e_u) \Rightarrow \diamond (c_t \vee c_u) \right)$$

“**Always**, if both t and u are trying to enter their critical sections, then t or u will **eventually** (in some future state) be inside its critical section.”

Or, equivalently: “Not all threads get stuck forever.”

Starvation freedom in LTL

Starvation occurs when one thread does not make progress; thus **starvation freedom** is when all threads make progress. For a program with two threads t and u , using the same propositions as before:

$$\square(e_t \Rightarrow \diamond c_t) \wedge \square(e_u \Rightarrow \diamond c_u)$$

“**Always**, if t is trying to enter its critical sections, **then** t will **eventually** be inside its critical section; and the same holds for u .”

Or, equivalently: “No threads get stuck forever.”

Counter without locks: mutual exclusion

Mutual exclusion in writing to counter: $\square \neg (C_t \wedge C_u)$, with n_t denoting that t is **not** in its critical section, and n_u denoting that u is **not** in its critical section.

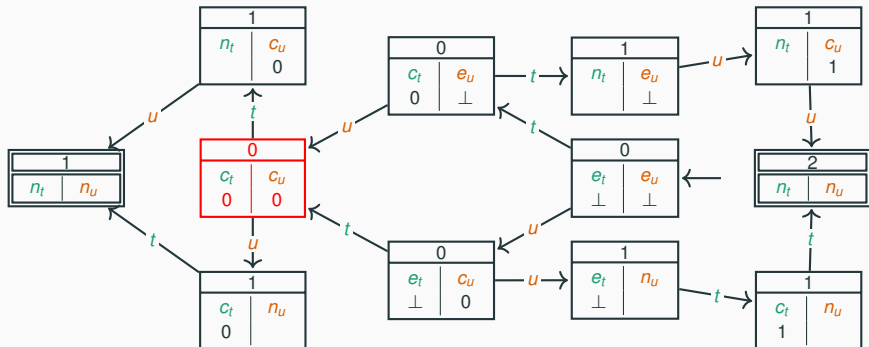

Counter with locks: mutual exclusion

Mutual exclusion in writing to counter: $\square \neg (C_t \wedge C_u)$, with n_t denoting that t is **not** in its critical section, and n_u denoting that u is **not** in its critical section.

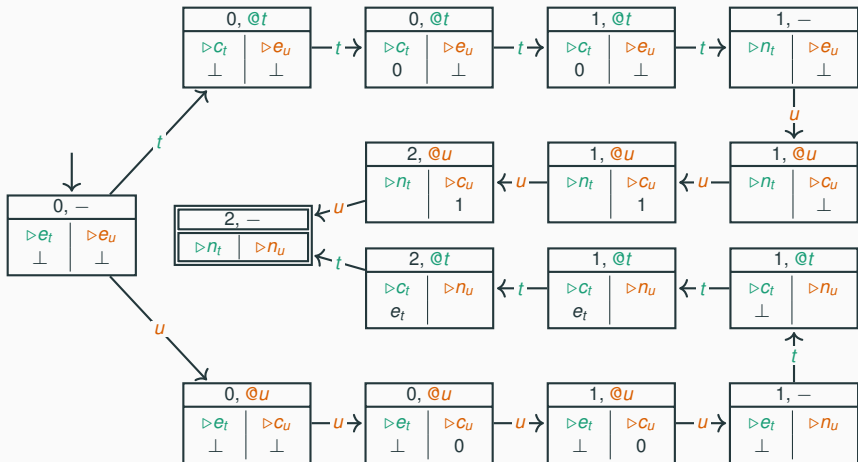

Counter with locks: mutual exclusion

Mutual exclusion in writing to counter: $\square \neg (C_t \wedge C_u)$, with n_t denoting that t is **not** in its critical section, and n_u denoting that u is **not** in its critical section.

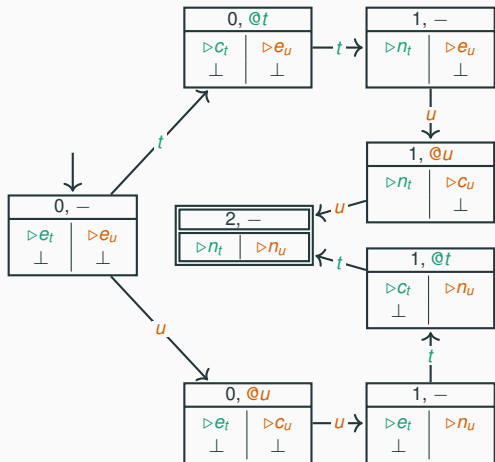

Counter with locks: deadlock and starvation freedom

Deadlock freedom: $\square \left((e_t \wedge e_u) \Rightarrow \diamond (c_t \vee c_u) \right)$

Starvation freedom: $\square (e_t \Rightarrow \diamond c_t) \wedge \square (e_u \Rightarrow \diamond c_u)$

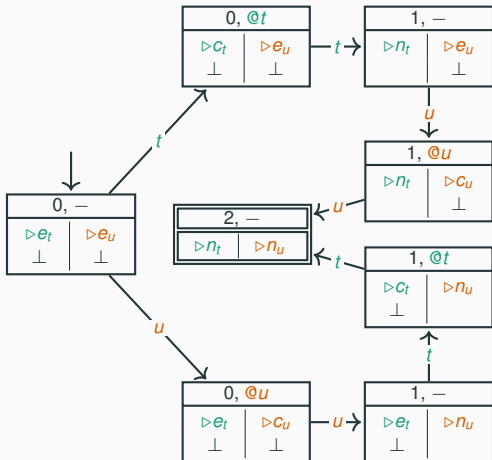

Verification

Verification

Verification is the process of **checking** that a program is **correct**. This means that, in addition to the implementation, there is also **some** form of **specification** (possibly only informal).

Two main techniques to do verification:

- **testing**: **run** the program using many different inputs and **check** that every run satisfies the specification;
- **formal verification**: mathematically **prove** that every possible run of the program satisfies the specification.

Verification

Testing

Testing

Testing in a nutshell:

- run the program using many different inputs,
- check that every run satisfies the specification.

Method `deposit` under test:

```
class BankAccount {  
    int balance;  
  
    void deposit(int amount);  
    void withdraw(int amount);  
}
```

Testing code:

```
BankAccount ba = new BankAccount();  
ba.deposit(100);  
check(ba.balance == 100);  
ba.deposit(20);  
check(ba.balance == 100 + 20);  
ba.withdraw(11);  
check(ba.balance == 100 + 20 - 11);  
// ...
```

Testing concurrent programs?

Testing is unreliable to find error in concurrent programs because of **nondeterminism**: a correct run does not guarantee that some other run **with the same input** will also be correct!

```
public class Counter
    implements Runnable
{
    // thread's computation:
    public void run() {
        int cnt = counter;
        counter = cnt + 1;
    }
}
```

```
Counter c = new Counter();
Thread t = new Thread(c);
Thread u = new Thread(c);
t.start();
u.start();
t.join();
u.join();
check(c.count() == 2);
```



sometimes it holds, sometimes it fails!

Testing deadlock freedom?

Besides nondeterminism, there is another problem that occurs if we try to test **temporal properties**.

- Testing **mutual exclusion**: if we run the program and detect that two threads are in their critical section at the same time, we know that there is a **bug**.
- Testing **deadlock freedom**: if we run the program and detect that all threads are blocked for, say, one hour, we still **cannot be sure** that they will be blocked there **forever**.

In simple examples, setting an arbitrary timeout may be enough, but in large systems with massive workloads it may be hard to figure out how much waiting time is to be expected.

Verification

Model checking

Safety and liveness properties

The difference between properties such as mutual exclusion and deadlock freedom is captured by two classes of temporal properties:

Safety properties are violated by a **finite trace**:

- informally: “nothing bad ever happens”
- example: mutual exclusion – a trace where, at some given time, two threads are both in their critical section shows that mutual exclusion does not hold

Liveness properties are violated only by an **infinite trace**:

- informally: “something good eventually happens”
- example: deadlock freedom – a trace where, from some time on, all threads are in the same state **forever** shows that deadlock freedom does not hold

Formal verification

Since testing is inadequate to reliably verify concurrent programs, **formal verification** is more widely used even if it is generally more difficult and expensive.

Remember that the specification of concurrent programs consists of two parts: **functional** and **temporal**. Verification proceeds as follows:

- first, prove that the **temporal** specification is always satisfied,
- then, **assume** the temporal specification and prove that the **functional** specification is always satisfied.

The advantages of this approach include:

- verifying a temporal specification alone often is feasible on **abstract models** of programs which ignore details such as the precise value of all variables;
- if a strong temporal specification holds, we can often verify the functional specification as if the program were **sequential** (because concurrent executions are free from race conditions!)

Formal verification of the counter

Verifying the concurrent counter:

- to prove mutual exclusion, we only analyze the **locking behavior** and ignore the exact value of counter;
- if mutual exclusion holds, the two threads execute **run sequentially**, thus we analyze the program as if it were sequential.

```
public class Counter
    implements Runnable
{
    // thread's computation:
    public void run() {
        lock();
        int cnt = counter;
        counter = cnt + 1;
        unlock();
    }
}
```

```
Counter c = new Counter();
Thread t = new Thread(c);
Thread u = new Thread(c);
t.start();
u.start();
t.join();
u.join();
check(c.count() == 2);
```

Model checking

Model checking is an effective technique to verify concurrent programs, first developed in the 1980s.

Model checking mainly targets the verification of **temporal specifications** – expressed in **temporal logic** – about the behavior of **state/transition diagrams** – also called transition systems or finite-state automata:

1. given a concurrent program, build a **state/transition diagram** using finitely many states that captures its **concurrent behavior**
2. model checking algorithms analyze all infinitely many **traces** of the state/transition diagram and check whether a given temporal logic specification holds:
 - if model checking is successful, we have verified that **all** executions of the program satisfy the temporal specification
 - if model checking is unsuccessful, it returns a **counterexample** – a concrete trace that shows that the temporal specification is violated

Model checking in practice

Building a state/transition diagram that correctly captures the behavior of a concurrent program is something that cannot always be done **automatically**. Model checking tools provide convenient languages to formalize concisely complex state/transition diagrams.

For example, this is a model of the concurrent behavior of the shared counter in ProMeLa – the input language of the **Spin model checker**:

```
int count = 0;
```

```
proctype IncThread() {  
    int tmp; tmp = count; count = tmp + 1;  
}
```

```
init { // spawn two threads running in parallel  
    run IncThread(); run IncThread();  
}
```

Model checking techniques and tools

There are two large families of model-checking techniques and tools:

- **Explicit-state** model checking works by explicitly exploring the state space generated by a given state/transition diagram.
Spin is the most popular explicit-state model checker.
- **Symbolic** model checking works by encoding a given state/transition diagram using logic formulas (or other specialized data structures), and then expressing the temporal properties as logic properties of the encoding.
NuSMV is a state-of-the-art symbolic model checker.

To know more about model checking: course “Formal methods for software development”

These slides' license

© 2016–2019 Carlo A. Furia, Sandro Stucki



Except where otherwise noted, this work is licensed under the Creative Commons Attribution-ShareAlike 4.0 International License.

To view a copy of this license, visit

<http://creativecommons.org/licenses/by-sa/4.0/>.